

3M™ Ultra Conformable Flashing Tape 3015UC

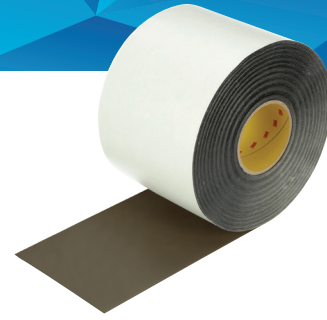

3M™ Ultra Conformable Flashing Tape 3015UC is a proprietary 3M detailing tape designed for the commercial construction market to be used in conjunction with a 3M™ Commercial Air Barrier System. It is constructed with a unique 3M backing that allows up to 370% elongation in multiple directions, enabling contractors to detail windows and other complex penetrations up to 40% faster by not having to cut and splice multiple pieces of tape. 3M™ Acrylic Adhesive allows the application of 3M™ Ultra Conformable Flashing Tape 3015UC at temperatures as low as 0°F and as high as 150°F. 3M™ Ultra Conformable Flashing Tape 3015UC can be left exposed to direct sunlight for up to 12 months. It is re-positionable, yet will adhere to and accept adhesion from most common building substrates per criteria of AAMA 711-13 using test method ASTM C794. 3M™ Ultra Conformable Flashing Tape 3015UC is available in 2", 6" and 9" widths.

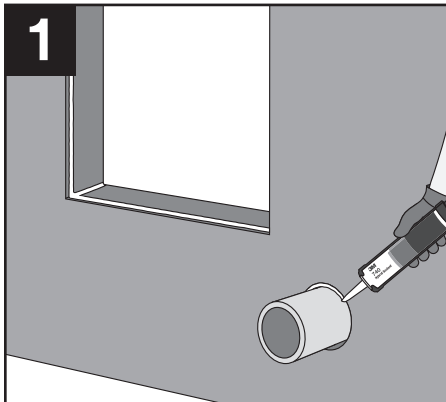

1
Prep window opening and penetrations. Caulk gaps and ensure all mortar joints are struck flush. Gaps wider than 1/2" must be filled with backer rod and caulk prior to applying 3M™ Ultra Conformable Flashing Tape 3015UC.

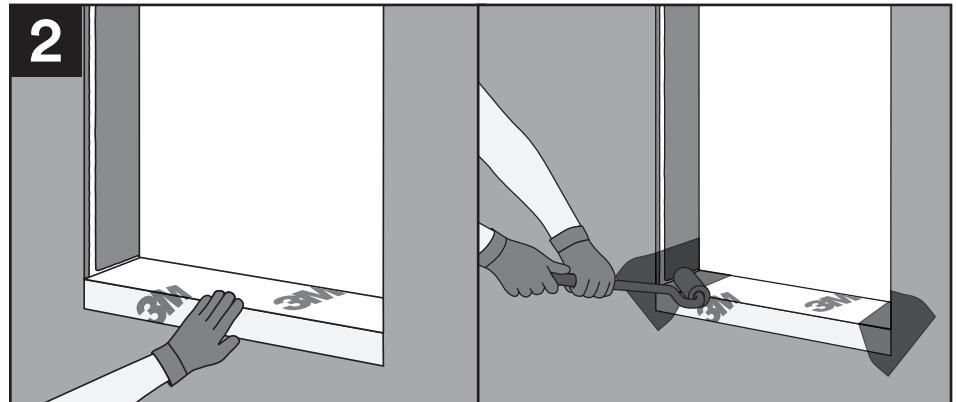

2
If 3M™ Air and Vapor Barrier 3015 will be used as the sill flashing tape, first cut it the width of the window and apply over the sill extending at least 2" onto the wall. Then apply 3M™ Ultra Conformable Flashing Tape 3015UC in the corners, extending over the sill tape and up the vertical side of the frame ensuring a minimum 2" overlap in all directions. Apply pressure with a J-roller.

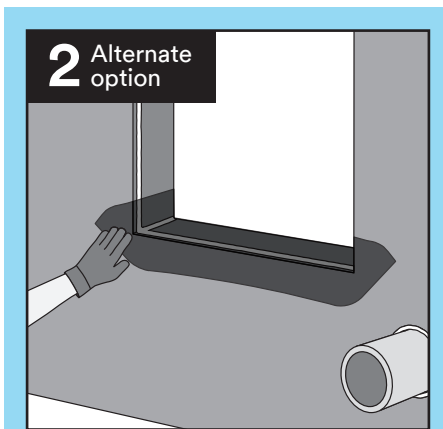

2 Alternate option Sill Flashing — 3015UC Only

A 9" wide strip of 3M™ Ultra Conformable Flashing Tape 3015UC can be applied across the entire sill in one continuous piece extending at least 2" onto the wall and up the vertical sides of the frame.

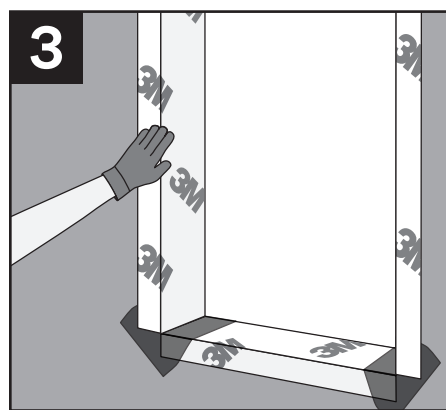

3
To detail the vertical sides of window, cut 3M™ Air and Vapor Barrier 3015 the same length as the height of the frame. Extend onto the wall and overlap the sill flashing a minimum of 2" to prevent negative laps.

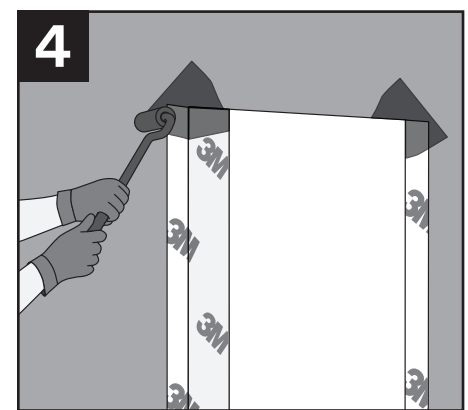

4
Apply 3M™ Ultra Conformable Flashing Tape 3015UC in the corners, extending over the vertical sides of window flashing and directly to the wall. Ensure tape is applied with a 2" minimum overlap in all directions.

3M™ Ultra Conformable Flashing Tape 3015UC (cont.)

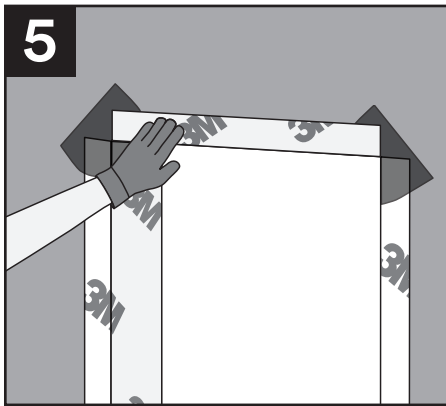

To complete the window detailing, cut a piece of 3M™ Air and Vapor Barrier 3015 the same width as the window. Overlap a minimum of 2" onto the wall and over the 3M™ Ultra Conformable Flashing Tape 3015UC in the upper corners.

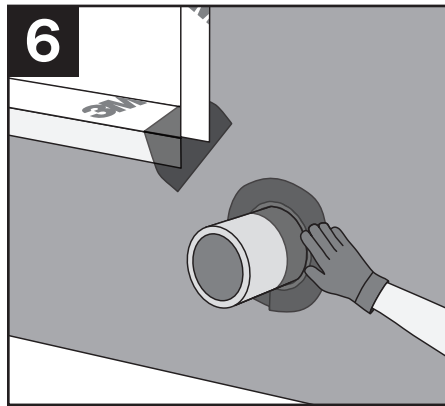

Detail penetrations by wrapping 3M™ Ultra Conformable Flashing Tape 3015UC around the penetration, ensuring the lap ends at the bottom with a minimum of a 2" overlap.

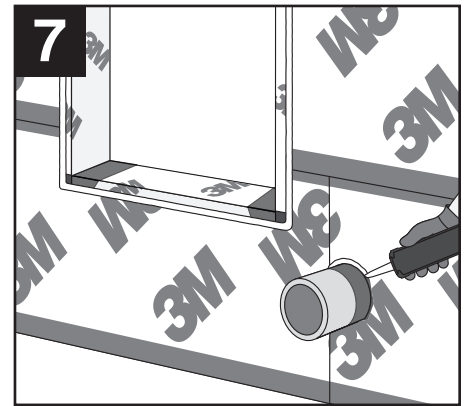

Any negative laps and penetrations need to be caulked after the wall air barrier is applied.

3M™ Ultra Conformable Flashing Tape 3015UC Best Practices

Substrate Surface Requirements

3M™ Ultra Conformable Flashing Tape 3015UC can be applied to a wide variety of sheathing substrates, typically without priming. Substrate condition is crucial to the adhesion performance of any adhesive membrane.

- Substrate surfaces must be free of grease, oil, un-bonded paint, corrosion or other substances that would adversely affect the adhesive bond between the membrane and substrate.
- Substrate surface must be dry to the touch for optimum performance.
- Application temperature must be between 0°F and 150°F (-18°C and 66°C).
- Service temperature from -40°F to 240°F (-40°C to 116°C).
- Rolls must be stored at a temperature between 0°F and 150°F (-18°C and 66°C) to ensure initial bond performance.

Surface Preparation

- Fill gaps and cracks exceeding 1/8" width with 3M™ Adhesive Sealant 740UV, and tool the surface flush and smooth. Fill gaps exceeding 1/2" width with closed cell foam backer rod or a foam seal, then with 3M™ Adhesive Sealant 740UV, and tool the surface flush and smooth.
- Concrete substrates shall have fins ground flush and void areas filled.
- Masonry substrates must have mortar joints struck flush.

Substrate Specific Guidelines

- Exterior gypsum sheathing shall have moisture content below 19%, with no open joints or cracks wider than 1/2".

Learn about 3M's advanced technologies for controlling airflow and optimizing the indoor climate at 3M.com/airbarrier or contact your 3M representative at 866-513-4026.



3M Industrial Adhesives and Tapes Division
3M Center, Building 225-3S-06
St. Paul, MN 55144-1000

Phone 866-513-4026
Web 3M.com/airbarrier

Technical Information: The technical information, guidance, and other statements contained in this document or otherwise provided by 3M are based upon records, tests, or experience that 3M believes to be reliable, but the accuracy, completeness, and representative nature of such information is not guaranteed. Such information is intended for people with knowledge and technical skills sufficient to assess and apply their own informed judgment to the information. No license under any 3M or third party intellectual property rights is granted or implied with this information. **Product Selection and Use:** Many factors beyond 3M's control and uniquely within user's knowledge and control can affect the use and performance of a 3M product in a particular application. As a result, customer is solely responsible for evaluating the product and determining whether it is appropriate and suitable for customer's application, including conducting a workplace hazard assessment and reviewing all applicable regulations and standards (e.g., OSHA, ANSI, etc.). Failure to properly evaluate, select, and use a 3M product and appropriate safety products, or to meet all applicable safety regulations, may result in injury, sickness, death, and/or harm to property. **Warranty, Limited Remedy, and Disclaimer:** Unless a different warranty is specifically stated on the applicable 3M product packaging or product literature (in which case such warranty governs), 3M warrants that each 3M product meets the applicable 3M product specification at the time 3M ships the product. 3M MAKES NO OTHER WARRANTIES OR CONDITIONS, EXPRESS OR IMPLIED, INCLUDING, BUT NOT LIMITED TO, ANY IMPLIED WARRANTY OR CONDITION OF MERCHANTABILITY, FITNESS FOR A PARTICULAR PURPOSE, OR ARISING OUT OF A COURSE OF DEALING, CUSTOM, OR USAGE OF TRADE. If a 3M product does not conform to this warranty, then the sole and exclusive remedy is, at 3M's option, replacement of the 3M product or refund of the purchase price. **Limitation of Liability:** Except for the limited remedy stated above, and except to the extent prohibited by law, 3M will not be liable for any loss or damage arising from or related to the 3M product, whether direct, indirect, special, incidental, or consequential (including, but not limited to, lost profits or business opportunity), regardless of the legal or equitable theory asserted, including, but not limited to, warranty, contract, negligence, or strict liability.

3M is a trademark of 3M Company. © 3M 2019. All rights reserved.